



A R M O U R   S I D E

**BOARD + BATTEN INSTALLATION GUIDE**

**03** TOOLS & EQUIPMENT

**04** PROFILES

**05** PRODUCT KNOWLEDGE

**11** CUTTING STEEL SIDING

**12** BEST PRACTICES

**13** BOX BASE INSTALLATION

**16** PANEL INSTALLATION

**19** FINISHING PANEL RUN

**22** CAD DRAWINGS

## Introduction

The following **ARMOUR SIDE** Guide has been prepared and intended for persons with experience in the field of siding and soffit installation who have a fundamental knowledge of basic building practices.

**ARMOUR SIDE** is designed to be efficient and relatively simple to install, but precision and attention to detail is required for a successful install and it is highly recommended that an experienced professional install the product.

The information provided in this document is offered in good faith and believed to be reliable, but is made without warranty, express or implied, as to merchantability or fitness for a particular purpose. Readers should review this document in conjunction with their design professional's advice, construction drawings, manufacturer's technical literature, building code, and fire code. ARMOUR SIDE does not assume any responsibility for reader's compliance with applicable laws and regulations. The techniques discussed in this manual are illustrative of the procedures covered. They are not intended to be fully exhaustive and definitive.

**Warranty may be void if proper application and installation practices are not followed.**

## Required Tools

### TOOLS

- Drill
- Tape Measure
- Utility Knife
- Steel Snips
- Eye Protection
- Flathead Screwdriver
- Screws
- Armour Side Clips

### ADDITIONAL ITEMS

- Caulking Gun
- Leveling Square
- Level
- Needle Nose Pliers
- Steel Protective Glove
- Carpenters Pencil
- Touch Up Paint

## ARMOUR SIDE Features & Properties

**ARMOUR SIDE** is a 28 gauge ASTM A792 55% Al-Zn Alloy Coated Steel that is pre-painted in a Triple Coat SMP high endurance textured paint. **ARMOUR SIDE** can withstand extreme weather changes, is impervious to insects, requires virtually no maintenance and is warranted for 40 year's. Unlike wood, it will never rot or support mold or mildew and is easy to clean and maintain.

## ARMOUR SIDE Board + Batten

**ARMOUR SIDE** Panels are available in a 12" (304.8 mm), 16" (406.4 mm) and 20" (508 mm).

### 12" Board

10' Length - 191100 | 13' Length - 191200

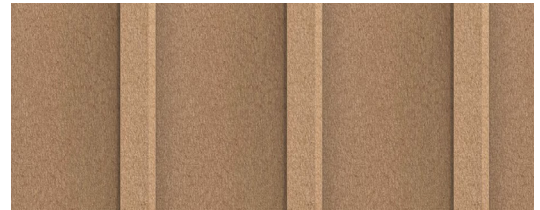
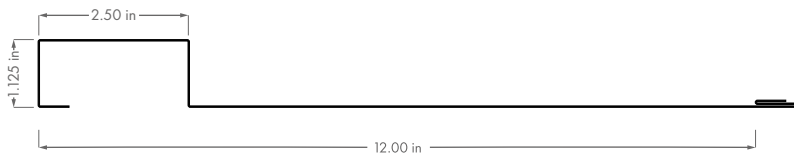

A. 12" Board + Batten

### 16" Board

10' Length - 191150 | 13' Length - 191250

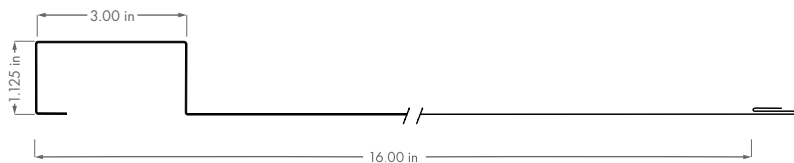

B. 16" Board + Batten

### 20" Board

10' Length - 191175 | 13' Length - 191275

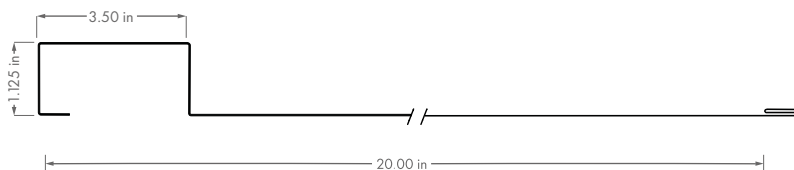

C. 20" Board + Batten

## Safety Considerations

Always wear and use appropriate Personal Protective Equipment (PPE), taking all precautions to protect eyes during installation and cutting. Gloves are recommended as there are sharp corners and edges on the bevel panels. When cutting or being exposed to airborne particles always wear an appropriate dust mask. Refer to the OHS (OSHA in the U.S.A) Code for further requirements and safety measures for jobsite siding installations.

## Transportation

**ARMOUR SIDE** securely packages and crates each Board and Batten order. To maintain integrity of the product, precautions must be used when loading and unloading the product. The product should be moved by forklift from the center of the crate, taking extra care not to hit the crate with the forks or allow the crate to twist. All custom cut shipments are photo-documented on the truck when they leave and must be in 100% manufacturer condition. When the products arrive, immediately check for any crate or product damage. Do not install damaged products.

## Storage

Pre-painted steel panels have been successfully used for many years. In general, properly installed panels under normal service conditions have excellent corrosion resistance. However, pre-painted building panels are subject to premature corrosion failures prior to installation if they are not handled and stored properly on the job site. Excessive storage periods or poor storage conditions often result in water intrusion into panel bundles. Prolonged exposure of bundled panels to wet conditions can cause paint blistering and substrate corrosion. Wet Stack Corrosion in the right conditions can manifest itself in as little as 2 weeks, but typically after 4 weeks early stages of adhesion failure can be detected on panels.

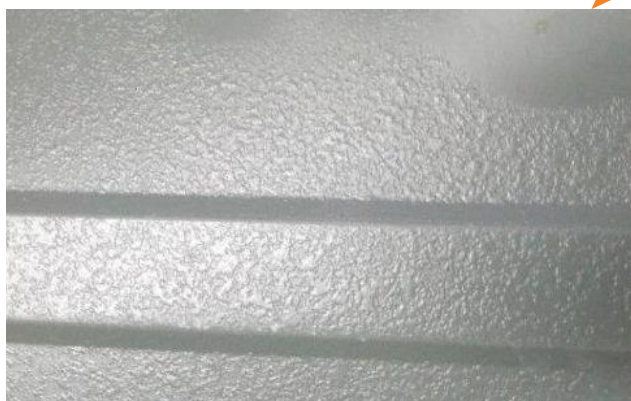

*Close-up image of severe "Wet Stack Corrosion." Note smooth, normal surface in upper right corner.*



*Note when scratched, the primer has been compromised as well as the presence of Zinc Oxide (white rust).*

## Storage Considerations

---

### Environmental & Service Conditions

Water is a necessary prerequisite for corrosion of stored pre-painted panels. When water or water vapor is available along the sides of a panel bundle, it may penetrate between the panels by capillary action. If proper precautions are not taken during transport, water may be present between the panels upon delivery at the job site. Ambient humidity and temperature cycles will also promote water intrusion into stored panel bundles through condensation. Finally, rain and snow are other potential sources of water that can cause storage corrosion of pre-painted panels.

Besides water, two other important factors that contribute to the corrosion of stored pre-painted panels are temperature and exposure time. Corrosion will accelerate with increased temperature. Given enough time, panel bundles will eventually become wet and storage corrosion may occur under most job site panels. Storage corrosion can be prevented by:

- Reducing site storage time.
- Decreasing water contact.
- Moderating temperature extremes.

Special case factors not considered here are the presence of aggressive soluble chemicals, such as sulphur and chlorine compounds, that might be present in polluted atmospheres, road salt contaminants, or marine environments. It is reasonable to assume that these soluble species would accelerate storage corrosion.

### Job Site Storage

Prolonged storage will always increase the likelihood of storage corrosion. Therefore, the best prevention is to minimize the storage time. Proper storage limits the collection of water from rain, snow and condensation on the panel surfaces. Under roof storage is always preferred. If panel boxes have to be stored outdoors, a number of precautions must be taken to prevent storage corrosion. The panel boxes should be stored in a level area out of the way of other construction activities to minimize the number of box movements required at the job site. If the boxes are stored on the ground, a plastic ground cover must be put down under the boxes to minimize condensation of water from the ground onto the panels. The boxes must then be raised off the plastic ground cover to avoid contact with water puddles, and allow for air circulation around the boxes to promote drying of condensed water.

Wet, uncured or pretreated lumber should not come in contact with the panel boxes or panels. The panels must be stored on an angle to promote drainage of water off the boxes. Sufficient support must be provided to the raised and angled boxes to avoid any bowing, which may result in low spots that could hold water.

The boxes must be completely sheltered with a loose fitting waterproof tarp to protect the boxes during rain or snow events, but allow for air circulation and drying of condensed water. A loose fitting tarp also shadows any exposes panels in the boxes from direct sun light and should act to moderate high temperature extremes.

## Storage Considerations

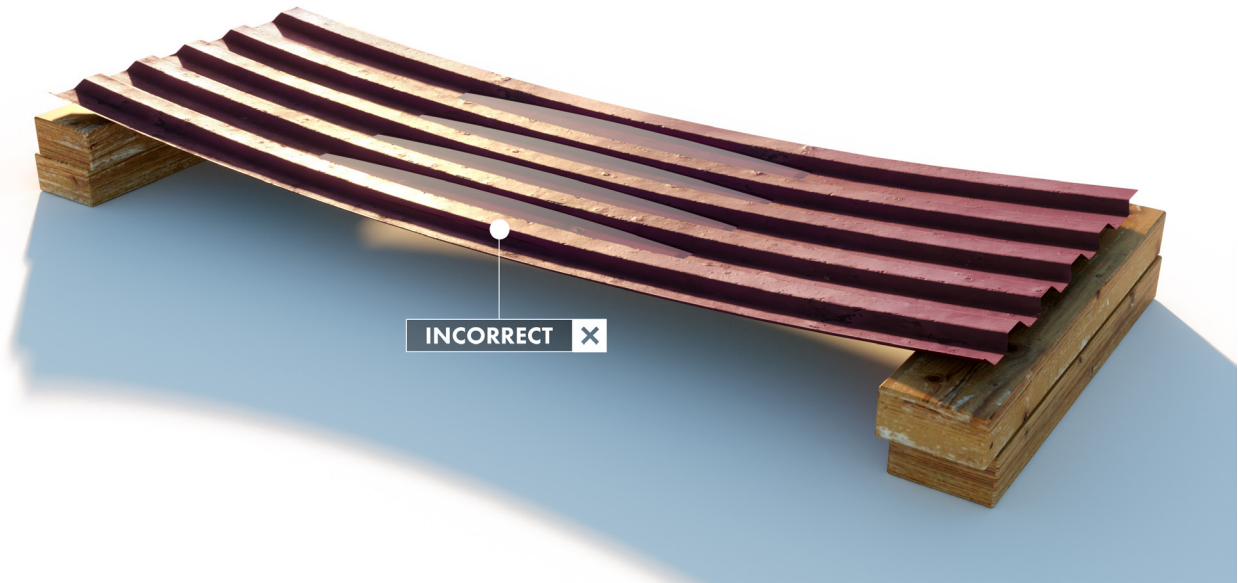

*Insufficient support in the center of long panels allow "Bowing" or "Sagging" that traps water in the center of the panel length.*

It is important NOT to snugly cover any exposed panels with a tarp when on the ground. By covering pre-painted panels in this manner, air flow is prevented and moisture in the ground under the tarp is trapped under the tarp and impregnates the panels. The effect is worse than just letting the bundles of pre-painted panels sit uncovered in the rain. This is because a "humidity chamber" has been created, and sunlight will heat the tarp and accelerate corrosion by means of increased humidity pulled from the ground below.

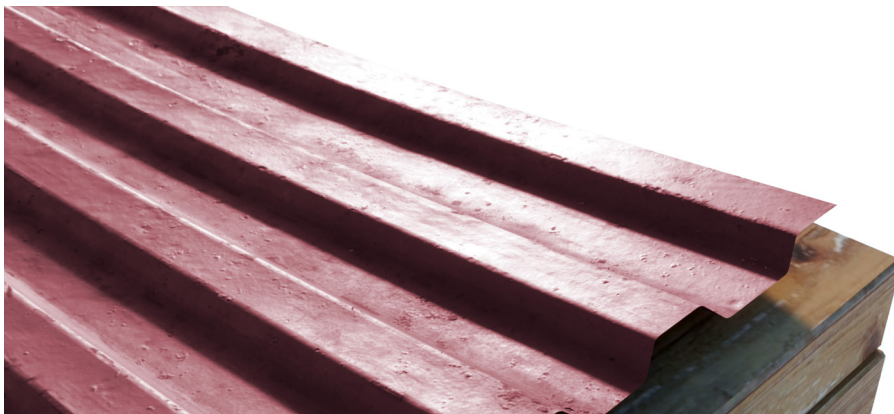

*After just 3 months covered in the manner above, the panel bundle is opened to reveal that moisture has made its way into the layers of sheets.*

Proper storage of bundled pre-painted panels is important and to some to be considered "time consuming and costly" to do. However, failure of your panels is an even more costly idea when you have to reorder and wait for delivery. Other costs associated with delays in job site completion as well as material replacement are things to consider when debating the use of proper storage methods.

## Storage Considerations

### NCCA Storage Methods

The National Coil Coaters Association (NCCA) has developed a time tested storage method for pre-painted, bundled panels. This section will lay out the steps for proper storage that will assure your panels remain dry and defect free when it comes time to install them on your structure.

### STEP 1

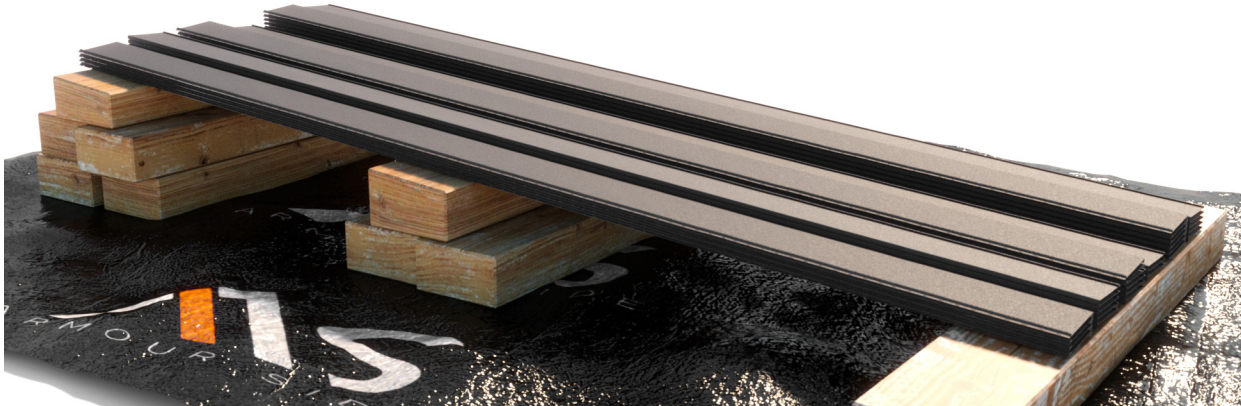

Your pre-painted bundle should be placed on a tarp to prevent ground moisture from being a factor. The bundle should then be placed on top in a sloping position. This allows any moisture that may already be present to gravitate out.

### STEP 2



Place scraps of dimensional lumber on the bundles "Cover Sheet". This is to keep the top tarp from resting directly on the panels to increase air flow which will allow moisture to escape.



If you roll the edges of the bottom tarp up as seen above, cutting a hole in the lowest area of the bottom tarp will allow water to escape.

## Storage Considerations

### STEP 3



Roll your top tarp over the stack allowing enough tarp to stretch out at least 12 inches from any edge of the panel stack.

### STEP 4

While using stakes and elastic straps, pull the top tarp tight enough to keep the edge off the ground, creating air flow under the bundle.

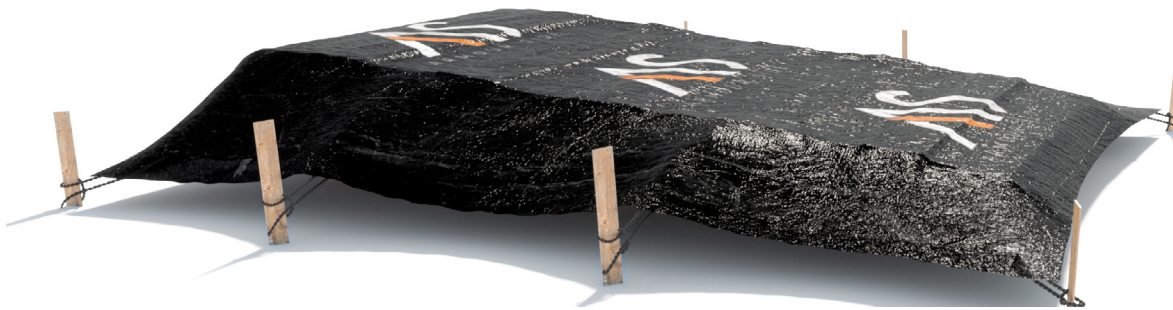

When completed, this method will increase storage life of your panels.

Unused portions of open boxes must be recovered. The condition of the tarps and paper wrapping of stored boxes and bundles should be inspected daily for damage, puddles and snow accumulation. Damage to packaging or tarps must be repaired and snow accumulation or puddles should be removed. If water is present in the panel boxes or bundles, the panels must be separated and wiped dry with a clean soft cloth and stacked with a space between each panel, so that air circulation can complete the drying process.

There is currently no test method to determine the storage corrosion resistance of pre-painted sheet products that has been correlated with actual storage performance; although, there are a number of test methods that have been utilized by the building products industry.

Any technical information or advice in this bulletin is provided without charge as a service to the industry. The use of this information or advice may produce unexpected results, and any persons intending to make use of this information are urged to carry out tests of their own to satisfy themselves they are using the correct materials, approach, and techniques. Correctly following the information and advice should produce a satisfactory result, but ARMOUR SIDE assumes no responsibility whatsoever in relation to such information or advice. Please ensure you have the most current Installation Manual.

## Unwrapped Products

Unwrapped or inadequately stored metal siding bundles can often result in water intrusion into panel bundles, causing potential damage such as component degradation, mold, paint degradation, rust, or the weakening of building materials. Pre-painted building panels are also subject to premature substrate corrosion and paint blistering if proper wrapping and storage considerations are not followed. It is the responsibility of the user to ensure proper storage and wrapping to prevent these issues. Failure to properly follow the wrapping, handling, and storage procedures outlined in this guide, or failure to protect your materials from moisture, will void any warranties. We assume no liability for damages resulting from inadequate wrapping, storage or protection methods.

## Warranty

Your warranty may be void if proper application practices are not followed. That includes the practices outlined in this guide as well as the **ARMOUR SIDE** Board + Batten installation guide. Additionally, your warranty may be void if you do not follow local building codes. The information provided in this document is reliable and offered in good faith but is made without warranty, expressed or implied, as to merchantability or fitness for a particular purpose. Readers should review this document in conjunction with their design professional's advice, construction drawings, manufacturer's technical literature, building code, and fire code. **ARMOUR SIDE** does not assume any responsibility for the reader's compliance with applicable laws and regulations.

## Code Compliance

The applicable Building Code and Fire Code are determined based on the project site location as there can be various code changes per province, city and region. **ARMOUR SIDE** Panels cannot address all the various codes in this guide. Project Designers, Builders, Architects and Engineers must understand the applicable code and install exterior cladding products within the guidelines of these codes. The requirements of the Local Building Codes must be observed as a minimum requirement of the installation of **ARMOUR SIDE** Panels.

## Temperature Consideration

While the expansion and contraction coefficient of **ARMOUR SIDE** is extremely low you must follow installation instructions regarding spacing against trims and by allowing the panel some room to float by not over-tightening fasteners.

## Care and Maintenance

While factory-applied finishes for metal building panels are so durable that they will last many years longer than ordinary paints, it is desirable to clean them thoroughly on a routine basis, especially when the finish is not washed by rain. Cleaning will generally restore the appearance of these buildings and residences. An occasional light cleaning will also help maintain an aesthetically pleasing appearance.

Examples of applications requiring maintenance cleaning and inspection include roof cladding, soffits, wall cladding under eaves, garage doors and the underside of eave gutters. Washing should be done at least every six months and more frequently in coastal areas where marine salt spray is prevalent and in areas where high levels of industrial fallout occur. Mild solutions of detergents or household ammonia will aid in the removal of most dirt, and the following are recommended levels:

1. One cup of detergent (example - Tide®) which contains less than 0.5% phosphate, dissolved into five gallons of warm water. (NOTE: The use of detergents containing greater than 0.5% phosphate is not recommended for use in general cleaning of building panels. **NEVER BLEND CLEANSERS AND BLEACH.**)
2. One cup of household ammonia dissolved into five gallons of water (at room temperature).

## Cutting ARMOUR SIDE

There are a number of ways to cut **ARMOUR SIDE** steel siding that will ensure the integrity of the product is maintained and the desired edge is created. For multiple straight cuts, a skill saw with a ferrous blade can be used. For more detailed cuts, using different types of snips can be both effective and easy. Plunge cutting can be hard on both your blade and the siding, leaving rough edges behind. Instead, use radial action to get safer, cleaner, and longer-lasting results.

Never use a zip disk to cut your **ARMOUR SIDE** product as this can burn both the finish and galvalume coating exposing the steel siding to corrosion. Always remove any particles of steel debris from the cutting process before installation as these particles can corrode damaging the finish of the **ARMOUR SIDE** product.

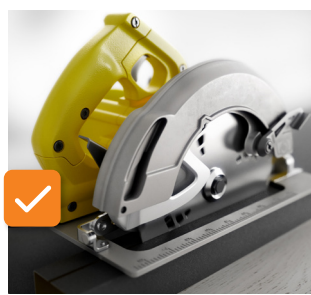

Any technical information or advice in this bulletin is provided without charge as a service to the industry. The use of this information or advice may produce unexpected results, and any persons intending to make use of this information are urged to carry out tests of their own to satisfy themselves they are using the correct materials, approach, and techniques.

Correctly following the information and advice should produce a satisfactory result, but ARMOUR SIDE assumes no responsibility whatsoever in relation to such information or advice. Please ensure you have the most current Installation Manual.

## Installation Tips & Best Practices

- Although highly consistent in colour and pattern, ordering all **ARMOUR SIDE** panels and trims at the same time will ensure colour continuity throughout the project. **ARMOUR SIDE** triple coat textured finish is produced in batches which may have slight shade variations between orders from different batches. Ordering a couple of extra panels and trims, in case of damage or a wrong cut, is standard practice and can save time and money for the overall project.
- **ARMOUR SIDE** panel is manufactured from cold rolled pre-finished steel which gives it superior strength and durability, however, **ARMOUR SIDE** panel can be damaged due to undo care or excessive pressure when fitting or handling.
- Over-tightening fasteners and not being diligent placing the nails in the center of the nail slots can cause the panel to deflect and possibly show "oil canning".
- Whenever possible, always pre-drill or prepunch trims and install with specified fasteners.



Malco metal punch is an excellent alternative to drilling as it cleanly punches nail sized holes without any damage or warping of surrounding material.



A R M O U R   S I D E

**BOARD & BATTEN BOX BASE INSTALLATION**

## Surface Preparation

The quality of a finished job depends on good preparation of the surface of your structure. Prepare wall by ensuring there is no rot or damage to underlying surface. Inspect wall surface for inconsistencies in substrate that would cause it to be wavy or uneven. These areas will need to be shimmed and adjusted ensuring the wall is completely flat and even before installation begins. The smoothness of the panel is determined by the smoothness of the wall it is being installed upon. Ensure potential air leaks are sealed, that there is nothing interfering with the new **ARMOUR SIDE** being installed and remove barriers such as downspouts, shutters, etc.

**\*Old siding should be removed before the installation of your new ARMOUR SIDE Products.**

## Box Base Installation

Before installation of your **ARMOUR SIDE** Products can begin, you must first install your accessories such as over & under window drip caps, window battens, corners, etc. in accordance with local building code.

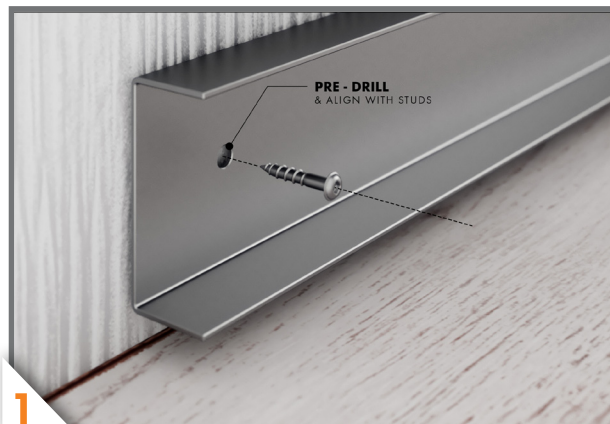

The Box Base and U-Support are key components when installing Board + Batten vertically. The Board + Batten needs a solid foundation to ensure there is no distortion or sliding of the panel. Screw holes should be pre-drilled in the U-support and aligned with substrate studs.

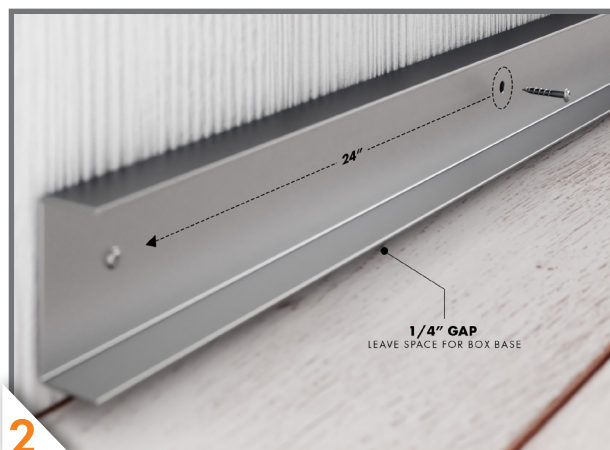

Before installing the U-Support, pre-drill your screw holes (no farther than 24" apart). Attach the U-Support 1/4" from the ground or bottom level. Screw in place using appropriate fasteners for wood or steel.

\*Always follow local building codes for the installation of rain screens.

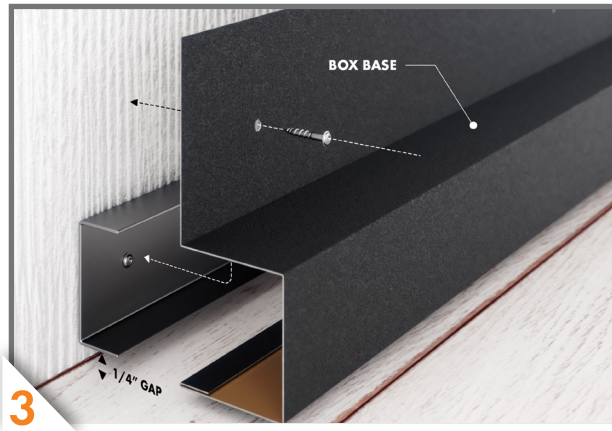

The next step is to measure & cut your Box Base to fit over your U-Support. Ensure that the top of the bend in the Box Base is seated on the top of the U-Support.



Pre-drill your holes and fasten the Box Base over the U-Support using the appropriate fasteners for wood or steel. Fasten the Box Base to the substrate studs.



A R M O U R   S I D E

**BOARD & BATTEN PANEL INSTALLATION**

## PANEL INSTALLATION

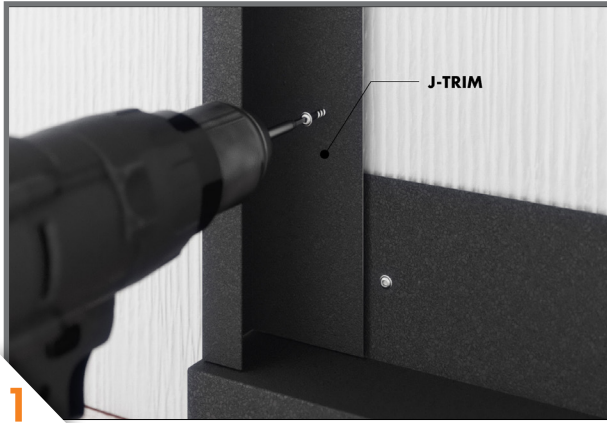

Here we have a J-Trim fastened over the Box Base. Once again, pre-drill your holes before fastening.



Next, a Starter Strip is installed over the J-Trim and above the Box Base. Leave a 1/2" gap between the starter and inside edge of the J-Trim. This provides space for the next Board + Batten panel to be fastened in place.

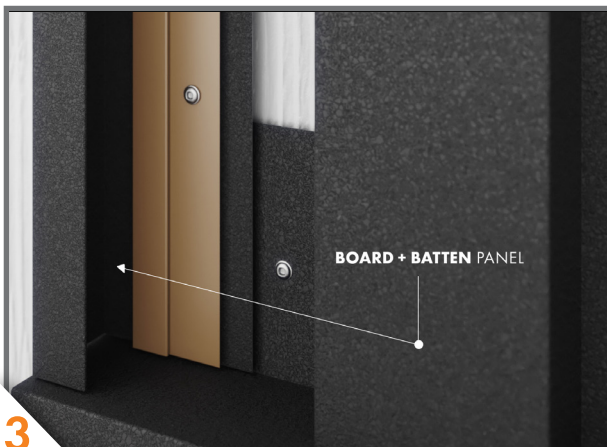

After the Starter Strip is fastened in place, slide the Board + Batten panel into the J-trim.

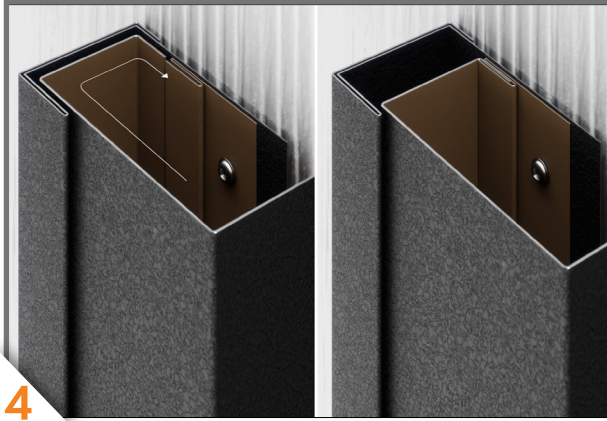

Pull the Board + Batten back and ensure it latches onto the Starter Strip.

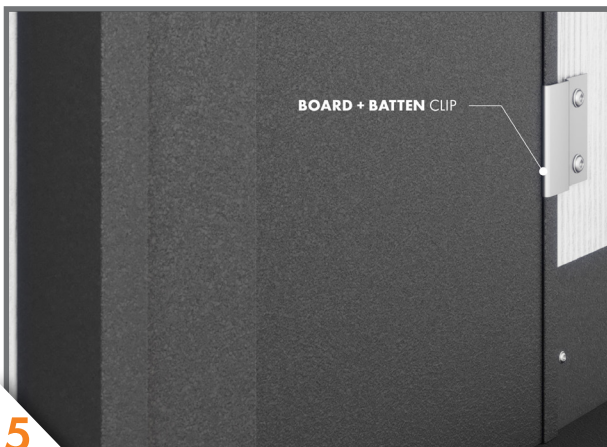

Once the Board + Batten is securely latched onto the Starter Strip, fasten your Board + Batten in place with a Board + Batten clip mounted on the hem of the panel.

Using the fastened Board + Batten clip, install your next panel and ensure it is securely latched on the Board + Batten clip.

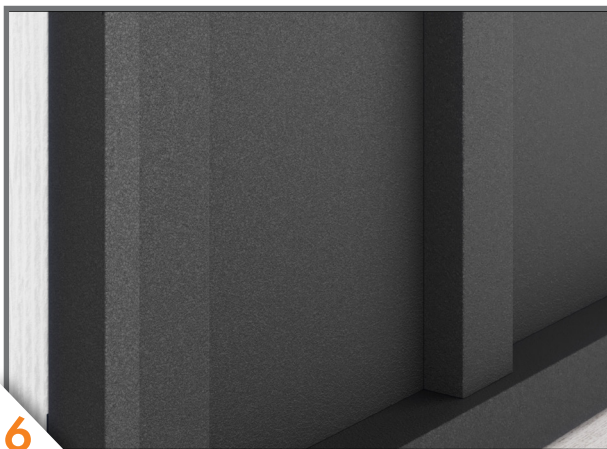

Continue the process and complete the installation of your Board + Batten section over the Box Base.



A R M O U R   S I D E

**BOARD & BATTEN FINISHING PANEL RUN**

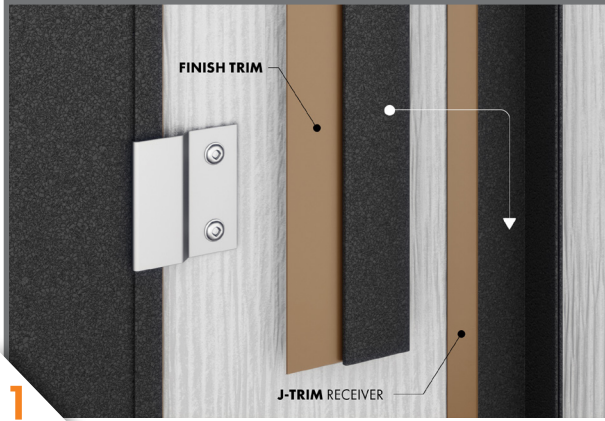

Finish your installation by fastening a Finishing Trim over the J-trim. Here we are using a 2 piece J to finish.

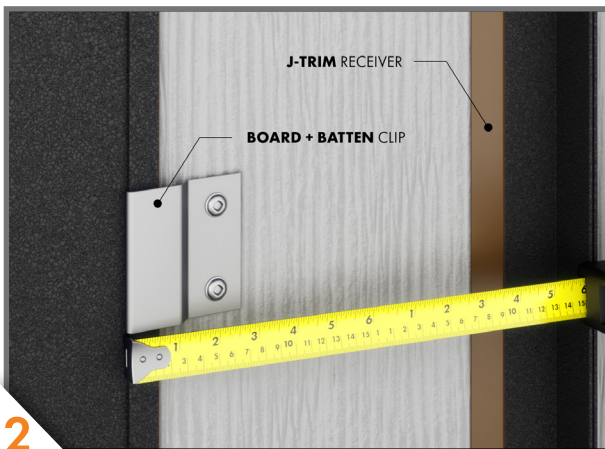

When installing the last panel, measure from the lower edge of the hem (from the previous panel) to the termination. Deduct 1/8" from your measurement.

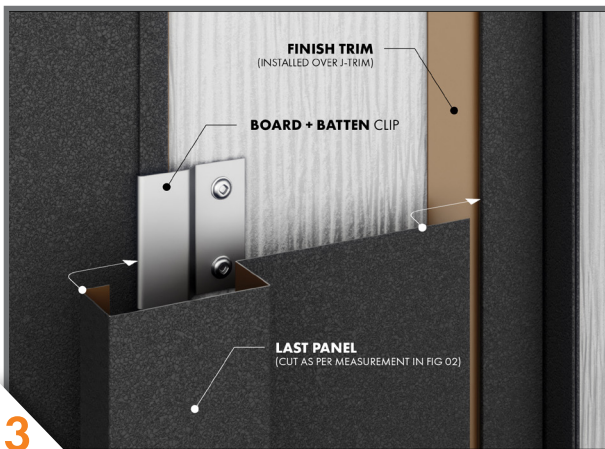

Slide in your last panel and using either silicone or crimps, secure the end of the panel in the hem of the Finishing Trim.



Finish by inserting the J insert.



A R M O U R   S I D E

**BOARD & BATTEN TRIMS & FINISHINGS**

## B + B J-Trim #191400

---

### Description:

Available in All Colours.

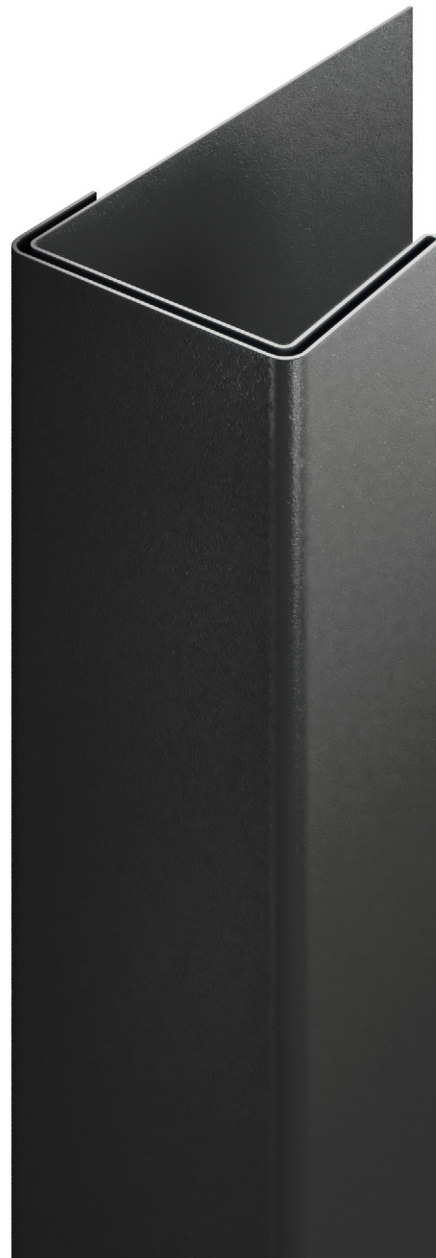
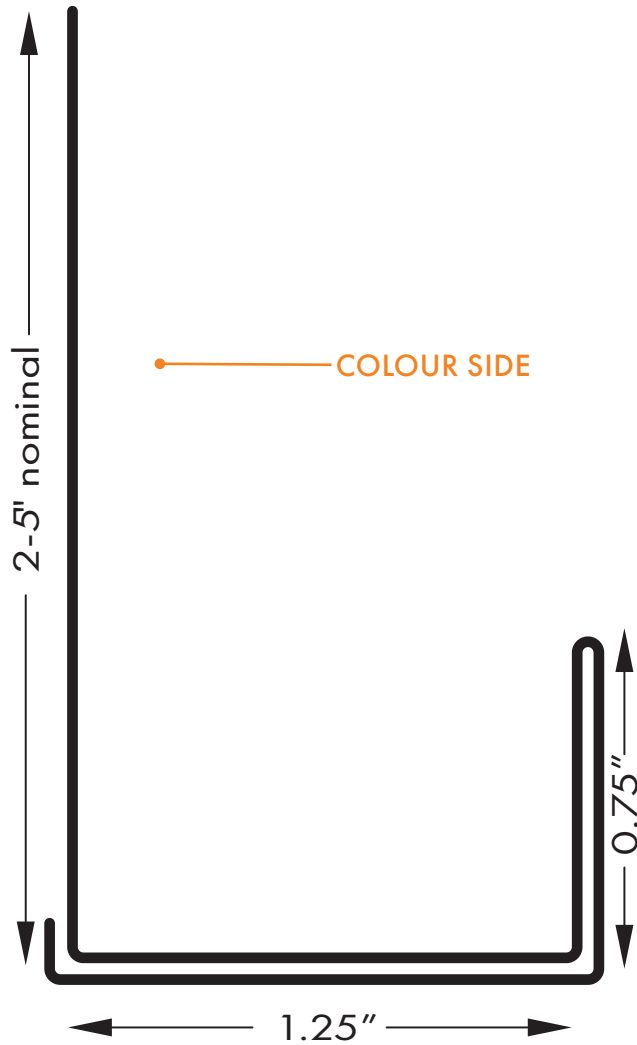

## B + B Beltline #191410

---

**Description:**

The B+B Beltline is MADE TO ORDER.  
Available in All Colours.

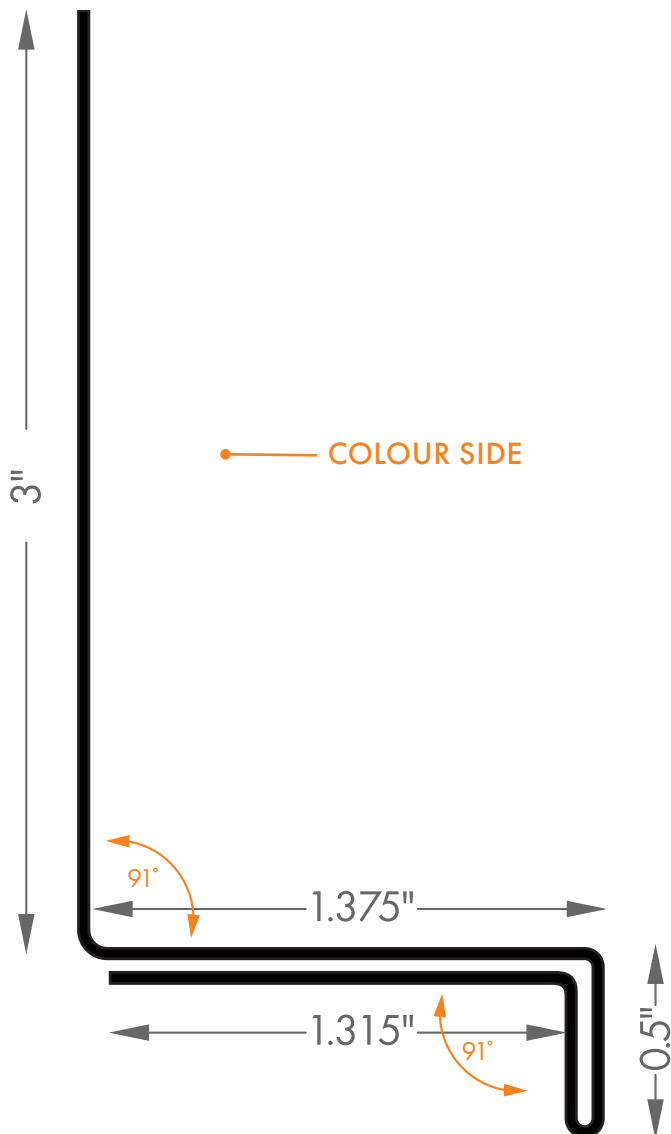

## Finish Trim #190035

---

**Description:**

Available in All Colours.

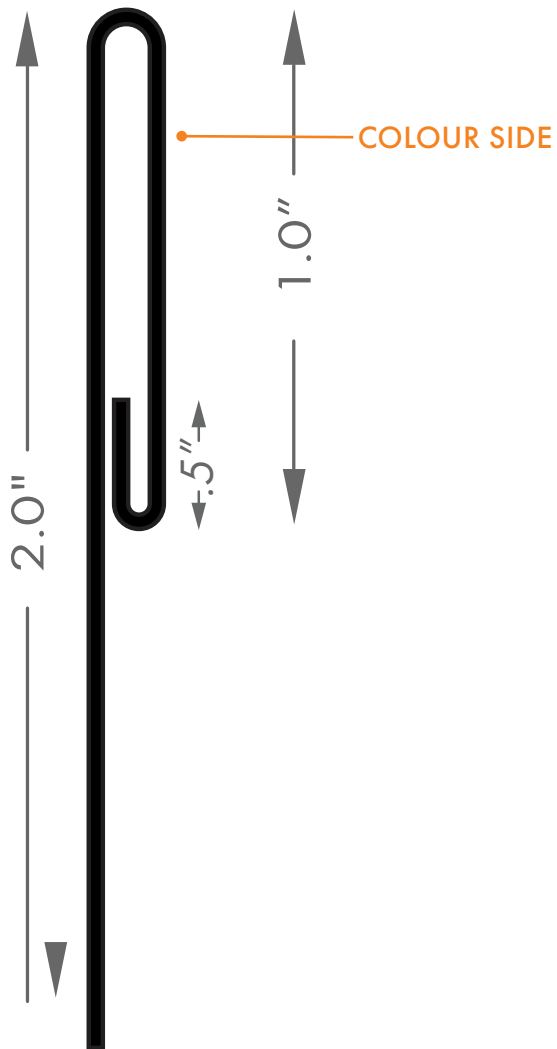

## B + B Outside Corner #191412

### Description:

The 3" Outside Corner is SPECIAL ORDER.  
Available in All Colours.

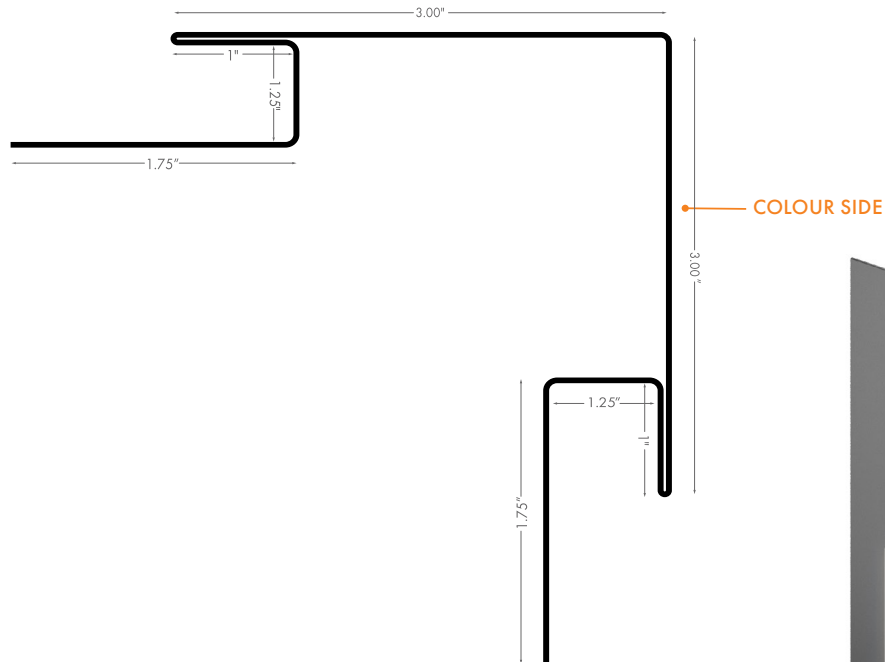

## Box Base #191420

---

### Description:

The Box Base Small is MADE TO ORDER.  
Available in All Colours.

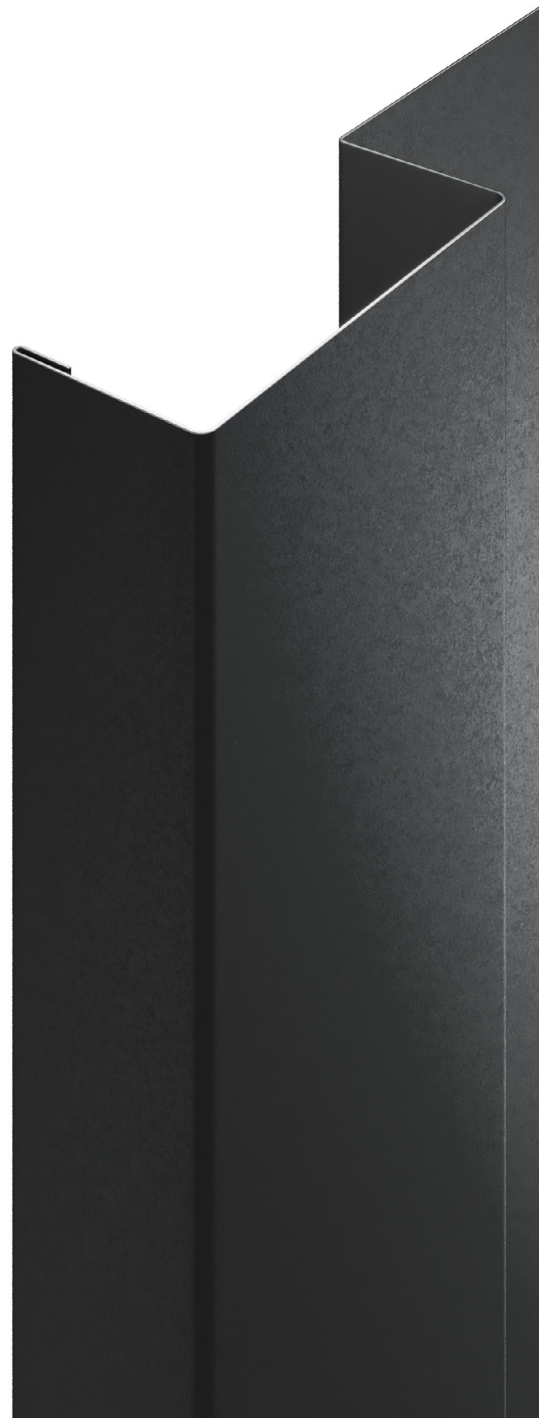
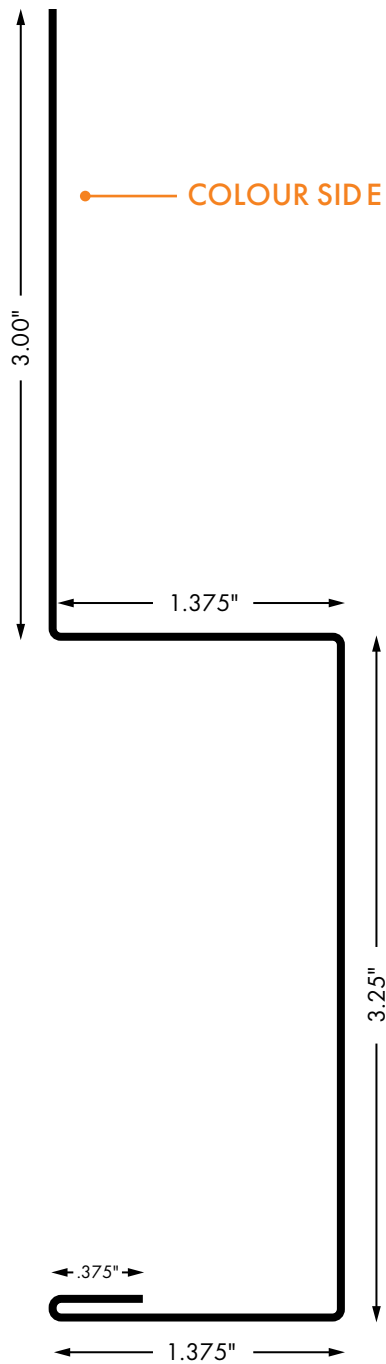

## Decorative Batten #191430

**Description:**

The Decorative Batten is MADE TO ORDER.  
Available in All Colours.

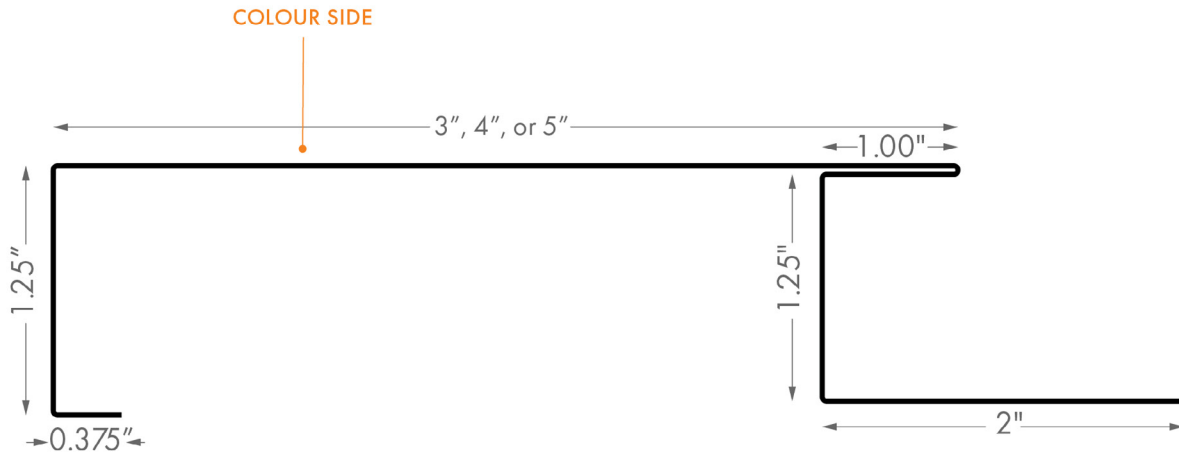

## Drip Cap #190060

---

**Description:**

Available in All Colours.

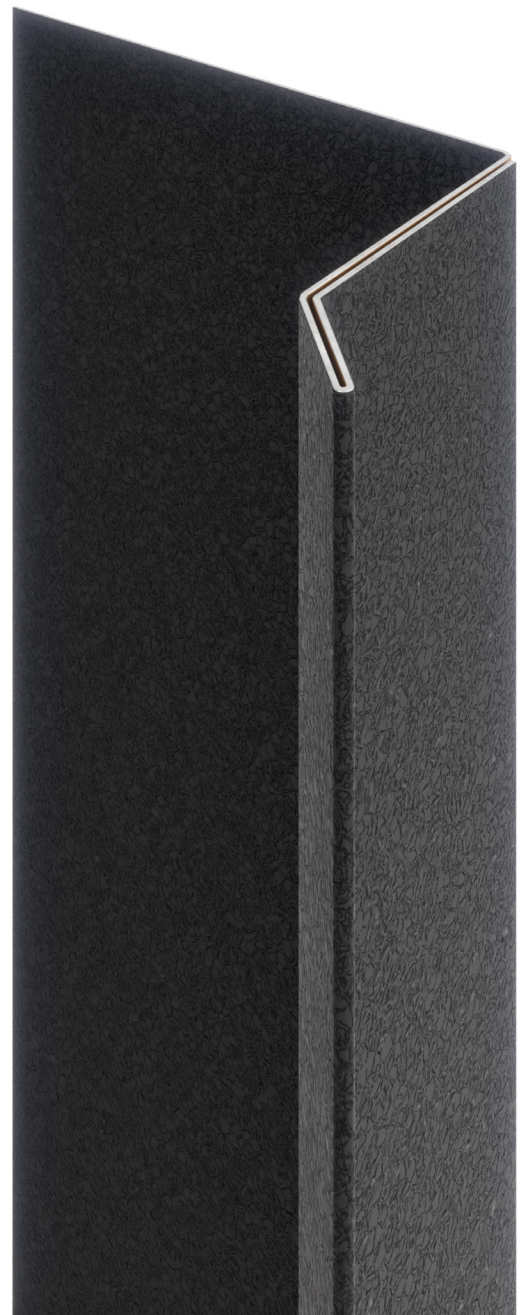
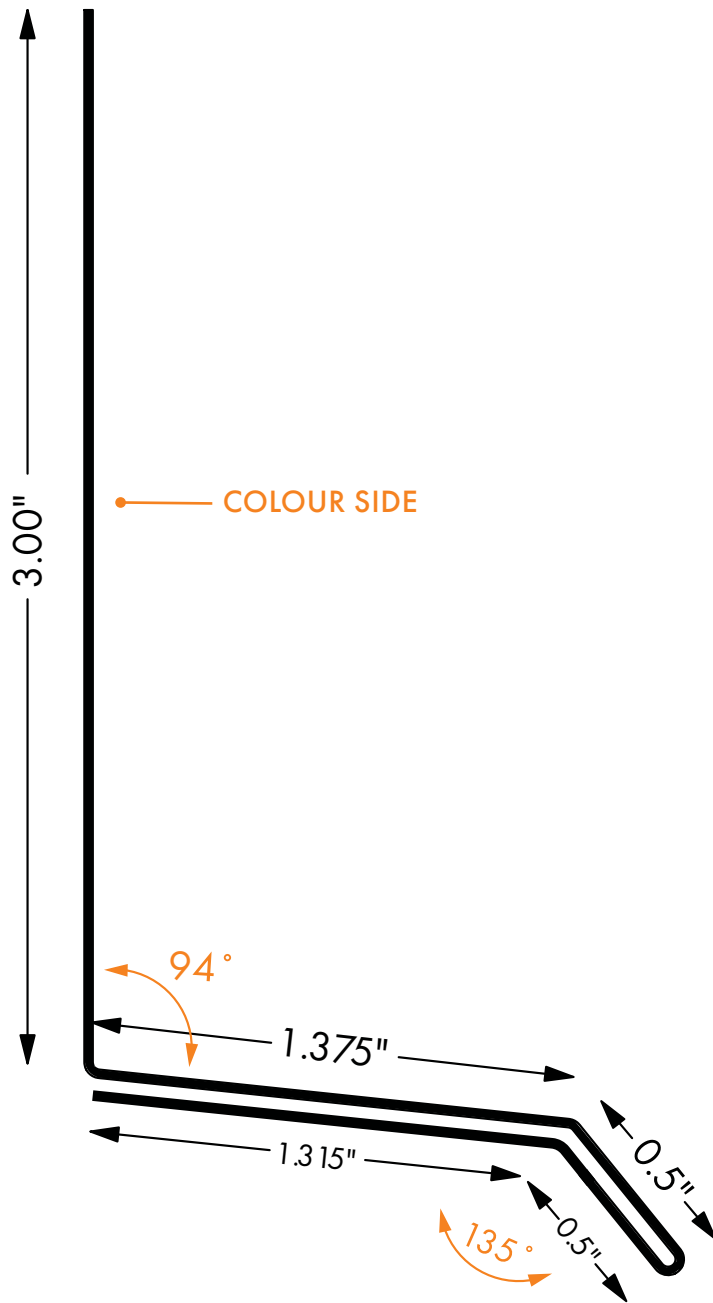

## Under Drip #190062

---

**Description:**

Available in All Colours.

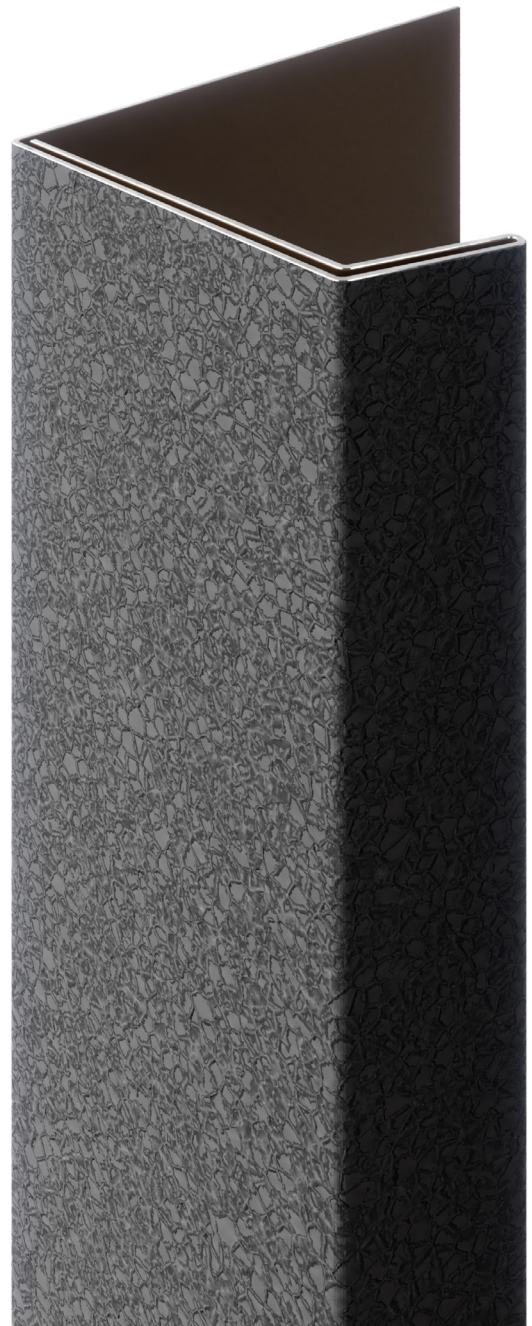
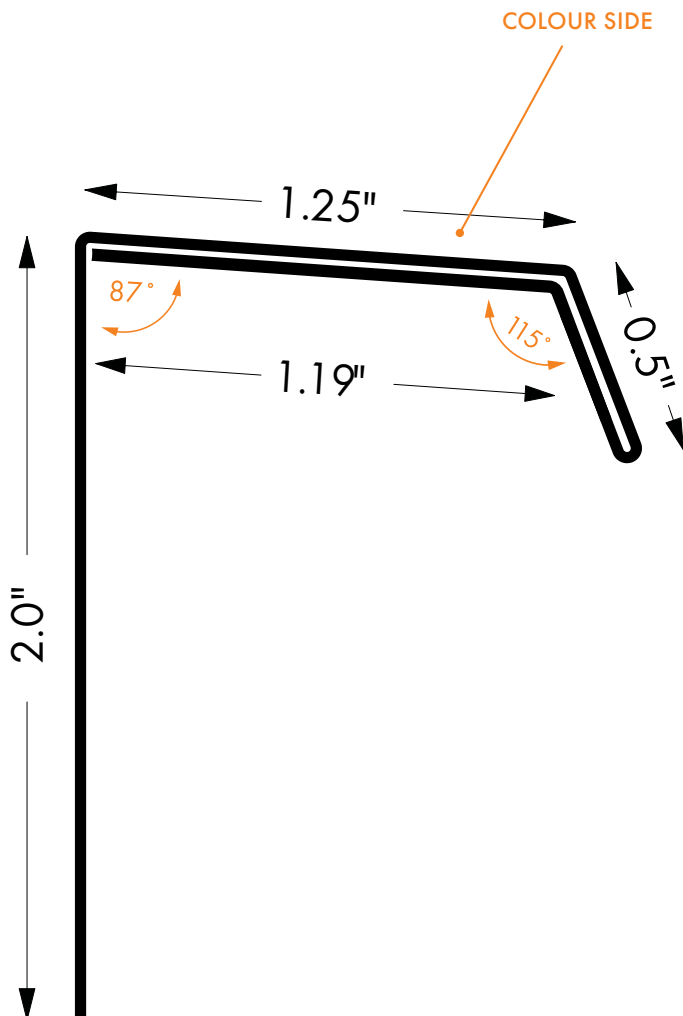

## B + B Starter #191480

---

### Description:

Not visible after siding is installed.  
Galvanized.

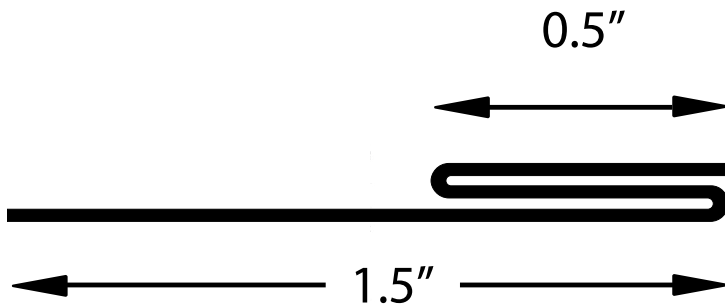

## U-Support #191430

---

**Description:**

Not visible after siding is installed.  
Galvanized.

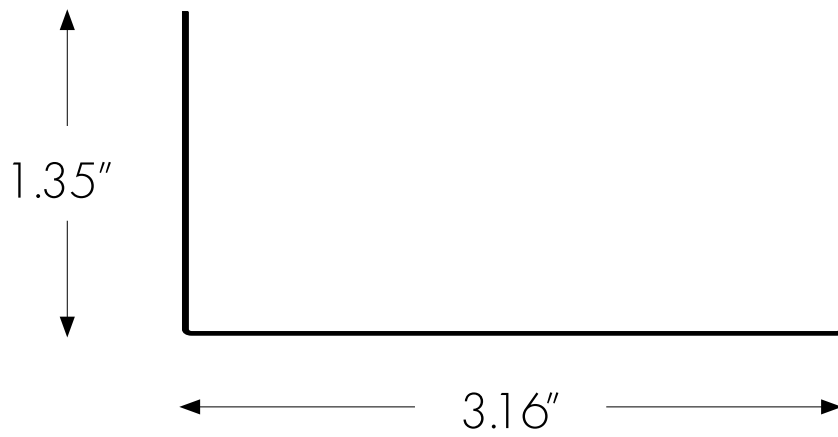

Board + Batten Clip #215083

---

